

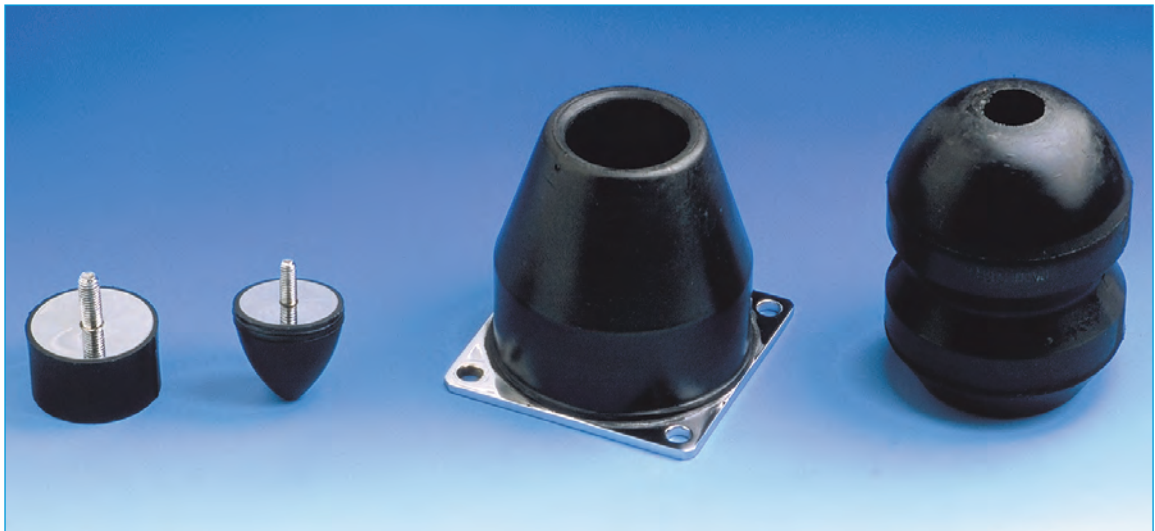

# TOPES

Ver también CALAS Y TAMPONES



Tope cilíndrico

Tope progresivo  
cónico

Tope progresivo  
LEVAFLEX

Tope EVIDGOM

## Descripción

Los topes son de varias clases :

- Tope cilíndrico o diábolo.
- Tope progresivo cónico.
- Tope progresivo LEVAFLEX con vaciado central.
- Tope EVIDGOM.

## Funcionamiento

La concepción de los topes PAULSTRA les confiere las propiedades fundamentales siguientes :

- Grandes deformaciones que permiten grandes absorciones de energía.
- Absorción progresiva de energía gracias a la estudiada forma del elastómero.

### Ventajas:

- En comparación con los topes rígidos, los topes elásticos PAULSTRA son silenciosos y evitan el desgaste y deterioro del material.

### Recomendaciones :

- El montaje debe hacerse de manera que, en el momento del impacto, el eje del tope sea perpendicular a la superficie de contacto.
- Cuando se produce el choque, el diámetro exterior del tope aumenta, por lo tanto hay que prever el espacio necesario en el momento del montaje.

# Características dimensionales y técnicas

## TOPES CILÍNDRICOS

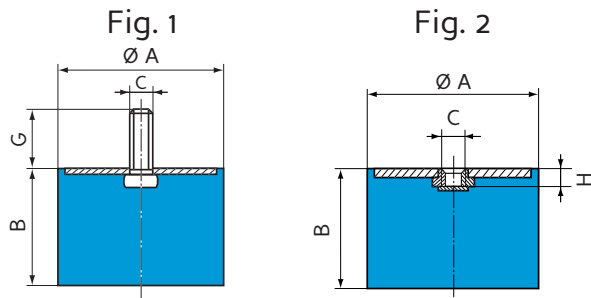

Ø A (mm)	B (mm)	C	G (mm)	Fig.	H (mm)	Carga máx. (daN)	Flecha (mm)	Energía (julios)	Referencia
12,5	10	M5	10	1	-	12	2	0,12	511110
	11					2,5	0,13	511128	
	10					3	0,16	511115	
	8					3,5	0,14	511125	
16	10	M4	10	1	-	20	2	0,20	511150
	15		1	-	20	3	0,30	511151	
	10		2	2,5	20	2	0,20	511152	
	15	-	2	2,5	20	3	0,30	511153	
	10	M5	12	1	-	20	2	0,20	511292
	15					20	3	0,30	511294
20	15					4	0,30	511296	
25	15	5	0,30	511298					
20	15	M6	-	2	4	35	4	0,70	511154
	40					1,5	0,30	511200	
	8,5	M6	16,5	1	-	35	4	0,70	511215
	15					30	5	0,70	511220
	20					30	5,5	0,80	511225
30	25	7	0,80	511230					
25,5	10	M6	18	1	-	80	2	0,80	511158
	15					60	3,5	1,00	511155
	20					50	5	1,20	511159
	30					50	8	2,00	511160
	15					60	3,5	1,00	511164
	20					55	5,5	1,20	511162
	30					50	8	2,00	511163

Ø A (mm)	B (mm)	C	G (mm)	Fig.	H (mm)	Carga máx. (daN)	Flecha (mm)	Energía (julios)	Referencia
25,5	10	M8	20	1	-	80	2	0,80	511265
	15					60	3,5	1,00	511270
	19					55	4,5	1,20	511251
	22					50	5,5	1,50	511275
	25					50	6	1,30	511280
	30					50	8	2,00	511285
40	50	10	2,50	511290					
30	22	M8	-	2	6	80	6	2,40	511156
	15					90	3,5	1,50	511308
	22					80	6	2,40	511310
	30					70	8	2,80	511312
40	60	9	2,70	511314					
40	30	M8	20	1	-	120	7	4,60	511157
	40					120	10	6,00	511161
	20	M10	25	1	-	160	5	4,00	511450
	25					150	6	4,50	511401
	35					120	8	4,80	511452
40	120	10	6,00	511454					
45	120	11	6,60	511456					
50	25	M10	25	1	-	300	6	9,00	511525
	35					250	9	11,20	511535
	45					190	11	10,00	511545
60	25	M10	25	1	-	400	6	12,00	511625
	36					300	9	13,50	511635
	45					250	11	13,70	511645
70	35	M10	25	1	-	450	9	20,00	511735
	50					350	12	21,00	511750
	70					300	14	21,00	511770
80	25	M14	45	1	-	1100	6	33,00	513801
	30					950	8	38,00	511830
	40					600	10	30,00	511840
	70					500	17	42,50	511870
	80					450	19	43,00	511880

Para saber la disponibilidad de piezas, consulte nuestra tarifa.

## TOPES PROGRESIVOS CÓNICOS

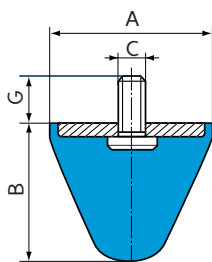

Referencia	Ø A (mm)	B (mm)	C	G (mm)	Choques repetitivos			Choques excepcionales Energía (julios)	Peso (g)
					Energía (julios)	Flecha (mm)	Reacción (daN)		
512251	25,5	19	M8	20	3	8	100	9	20
512307	30	30	M8	25	6	15	140	18	37
512301	30	30	M6	13,5	6	15	140	18	30
512515	50	50	M10	25	30	25	340	90	85
512501	50	50	M8	20	30	25	340	90	75
512516	50	64	M10	25	40	32	370	120	150
512502	50	64	M8	35	40	32	370	120	150
512517	50	58	M10	25	37	28	400	110	130
512503	50	58	M8	15	37	28	400	110	120
512608	60	40	M10	25	27	18	550	70	140
512601	60	40	M14	62	27	18	550	70	200
512700	72	58	M10	25	50	26	550	150	290
512721	72	58	M12	30	50	26	550	150	300
512951	95	80	M16	45	120	37	1100	350	750

Para saber la disponibilidad de piezas, consulte nuestra tarifa.

## TOPES DIÁBOLO

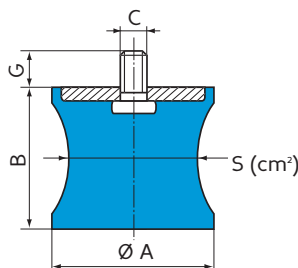

Referencia	S (cm²)	Ø A (mm)	B (mm)	C	G (mm)	Carga dinámica máx. (daN)	Flecha (mm)	Carga estática máx. (daN)	Flecha (mm)	Energía (julios)	Peso (g)
511571	5	57	42	M8	20	100	10	40	4	1	60
511572	9,5	57	42	M8	20	200	12	75	5,5	2	80
511601	19,5	60	57	M10	25	350	15	150	8	6	190
511801	38,5	80	65	M14	30	800	16	300	9,5	15	500
511951	50	95	70	M16	35	1000	18	400	9,5	20	790

Para saber la disponibilidad de piezas, consulte nuestra tarifa.

## TOPES PROGRESIVOS LEVAFLEX

Referencia	A (mm)	B (mm)	Ø C (mm)	D (mm)	Ø E (mm)	Ø G (mm)	H (mm)	Peso (g)
514085	85	85	8,5	69	8,5	20	5	600
514110	110	110	12,5	90	8,5	30	6	1200
514130	130	130	19	106	11	40	6	2000
514160	160	160	23	132	11	45	8	3000
514200	200	200	28	168	13	60	10	7000

Para saber la disponibilidad de piezas, consulte nuestra tarifa.

Choques repetitivos			Choques excepcionales energía (julios)	Referencia dureza
Energía (julios)	Flecha correspondiente (mm)	Reacción (daN)		
170	40	1200	500	514085/60
280	40	1700	850	514085/75
330	50	1800	1000	514110/60
550	50	3400	1500	514110/75
600	65	2800	1800	514130/60
650	60	3000	1900	514130/75
1050	75	4500	3000	514160/60
1200	90	4000	3600	514200/60
1300	70	6000	3900	514160/75
2200	85	7800	6600	514200/75

Para saber la disponibilidad de piezas, consulte nuestra tarifa.

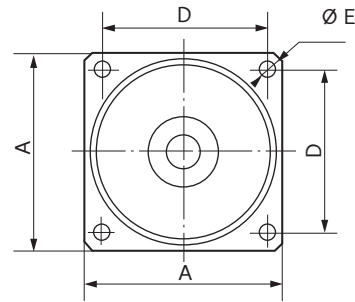
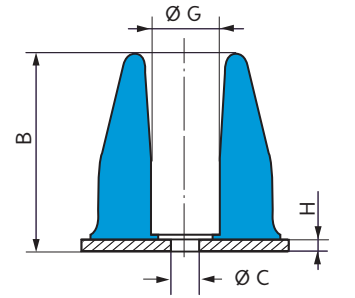

## TOPES EVIDGOM

Choques repetitivos			Choques excepcionales energía (julios)	Referencia dureza
Energía (julios)	Flecha correspondiente (mm)	Reacción (daN)		
31	30	190	95	810644
100	50	580	300	810645
110	45	600	330	810666
180	67	750	540	810642
350	75	1250	1050	810653
360	65	1400	1100	810655
400	85	1500	1200	810669
300	70	900	-	810784
600	75	1625	-	810775
1050	90	2375	-	810776
2500	90	5500	-	810733/60
7100	150	11000	-	810732/60
9500	200	9500	-	810731/60
13000	130	18000	-	810732/75
17500	175	19000	-	810731/75
21000	200	25000	-	810735/60
29000	250	35000	-	810734/60
41000	200	70000	-	810735/75
50000	250	55000	-	810734/75

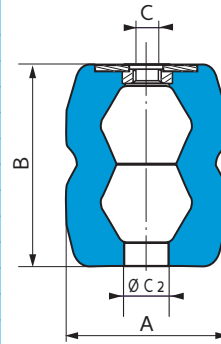

Fig. 1

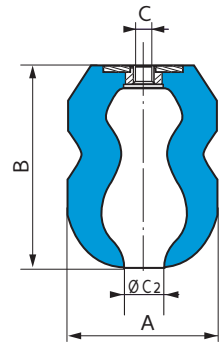

Fig. 2

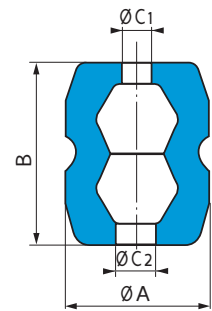

Fig. 3

Referencia tope	Fig.	Referencia Evidgom todo caucho	Ø A (mm)	B (mm)	C	Ø C1 (mm)	Ø C2 (mm)	Ø D (mm)	Ø A bajo carga (mm)
810642	1	810022	85	120	M16	20	30	-	114
810644	1	810004	55	55	M10	14	14	-	72
810645	2	810035	66	93	M16	20	14	-	100
810653	1	810023	100	130	M16	20	30	-	140
810655	1	810025	110	132	M16	20	30	-	142
810666	2	810046	76	90	M16	20	14	-	98
810669	2	810029	110	150	M16	20	30	-	155
810731	3	-	250	400	2x6xM24	70	70	150	360
810732	3	-	250	315	2x6xM24	70	70	150	380
810733	3	-	250	230	2x6xM24	70	70	150	370
810734	3	-	350	500	2x8xM24	85	85	196	445
810735	3	-	350	395	2x8xM24	85	85	196	500
810775	1	810015	155	150	M16	25	30	-	202
810776	1	810016	188	180	M24	40	40	-	256
810784	1	810014	125	140	M16	30	25	-	168

NOTA: Los valores indicados se entienden para condiciones de prueba correspondientes a una velocidad de impacto de 1 m/s. Para velocidades mayores, consultar con el Servicio Técnico de PAULSTRA.

# CURVAS DE FLEXIÓN Y VALORES DE ENERGÍA DE TOPES PROGRESIVOS, LEVAFLEX Y EVIDGOM

